

CATV TIA/Gain Block

TGA2803-SM

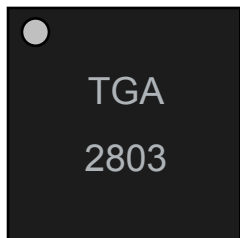

Top View

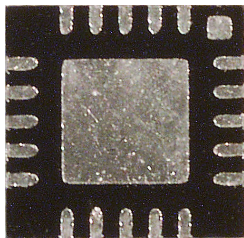

Bottom View

Product Description

The TriQuint TGA2803-SM is an ultra-linear, packaged TIA/Gain Block which operates from 40MHz to 1000MHz.

The TGA2803-SM typically provides flat gain along with ultra-low distortion. It also provides high output power with low DC power consumption.

This amplifier is ideally suited for use in CATV distribution systems or other applications requiring extremely low noise and distortion.

Demonstration Boards are available.

Lead-free and RoHS compliant.

**Typical 75 Ω Gain
w/External Balun Losses Removed**

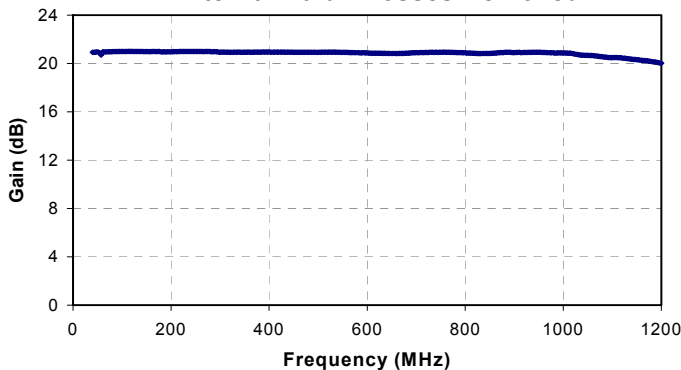

Key Features and Performance

- Frequency Range: 40MHz - 1GHz
- 20 dB Flat Gain
- 800 Ω Transimpedance *
- <math><5\text{pA}/\sqrt{\text{Hz}}</math> Equivalent Input Noise Current *
- 1.5 dB 75 Ω Noise Figure
- Ultra-Low Distortion (45dBm IP3 typ.)
- Low DC Power Consumption
- Single Supply Bias (+8V)
- Proven GaAs Technology
- 20L Package Dimension: 4.0 x 4.0 x 0.9 mm

* Includes 1:1 balun, No photodiode or auto-transformer

Primary Applications

- HFC Nodes
- CATV Line Amplifiers
- Head End Equipment

75 Ω Output TOI

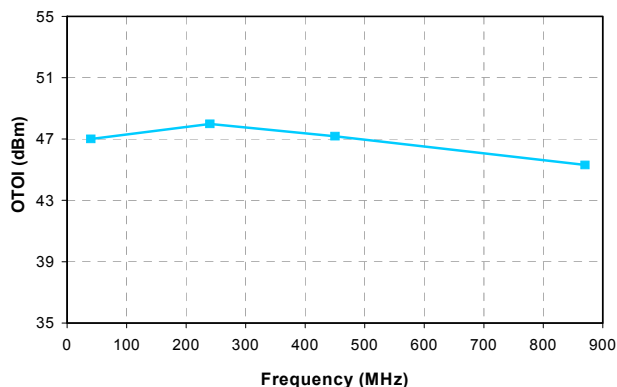

**Input Referred Current Noise
with High Impedance source**

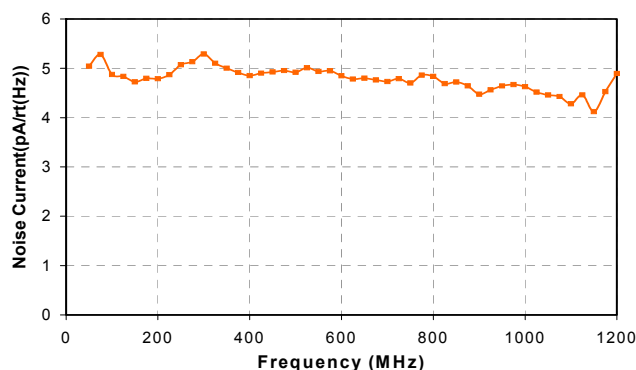

Table I
Maximum Ratings 1/

Symbol	Parameter	Min	Max	Units	Notes
V _{DD}	Bias Supply Voltage	0	15	V	
I _{DD}	Bias Supply Current		500	mA	<u>1/</u> <u>2/</u>
P _{IN}	RF Input Power		77	dBmV	<u>3/</u>
T _{ASSY}	Assembly Temperature (30 seconds max)		260	°C	
T _{CH}	Channel Temperature		150	°C	
T _{STG}	Storage Temperature	-65	150	°C	

1/ These values reflect maximum operable values for this device. Operating above the recommended values may directly affect T_m.

2/ Total Current

3/ Total Input Power

Table II
DC Specifications

Symbol	Parameter	Typ	Unit
V _{DD}	Bias Supply Voltage	8	V
I _{DD}	Bias Supply Current	350	mA
V _{G1}	Gate 1 Voltage (Pin 19)	0.90	V
V _{G2}	Gate 2 Voltage (Pin 7)	2.66	V
V _{out1}	RF Output 1 Voltage (Pin 14/15)	V _{DD}	V
V _{out2}	RF Output 2 Voltage (Pin 11/12)	V _{DD}	V

Table III
RF Specifications 1/
 $T_A=25^{\circ}\text{C}$, $V_{DD}=8\text{V}$

Symbol	Parameter	Min	Typ	Max	Units	Note
BW	Bandwidth	40		1000	MHz	
S_{21}	Power Gain	17	20	26	dB	<u>2/</u>
GF	Gain Flatness		± 0.3		dB	<u>2/</u>
NF	Noise Figure		1.5		dB	<u>2/</u>
TZ	Transimpedance		800		Ω	
I_n	Equivalent Input Current Noise		5		pA/rtHz	<u>4/</u>
IP_3	Two-Tone, Third-Order Intercept (450 MHz)		46		dBm	
IP_3	Two-Tone, Third-Order Intercept (750 MHz)	39	42		dBm	<u>2/ 3/</u>
	Harmonics (2^{nd} , 3^{rd} , 4^{th}) (40 to 500MHz)		-64	-58	dBc	<u>5/</u>
IRL	Input Return Loss		16		dB	
ORL	Output Return Loss		20		dB	
I_D	Drain Current		350	500	mA	<u>6/</u>
P_{sat}	Saturated Output Power (750 MHz)	26	28		dBm	

- 1/ Using electrical application circuit on pg. 8
2/ 1:1 Balun losses have been removed from the measurement
3/ Measured at 16dBm output power per tone
4/ Measured with open-circuited input
5/ Measured at 15dBm fundamental frequency output power
6/ Increasing drain current will improve linearity of device

TABLE IV
THERMAL INFORMATION

Parameter	Test Conditions	T_{CH} ($^{\circ}\text{C}$)	θ_{JC} ($^{\circ}\text{C}/\text{W}$)	T_M (HRS)
θ_{JC} Thermal Resistance (channel to backside of package)	$V_d = 8\text{ V}$ $I_d = 350\text{ mA}$ $P_{diss} = 2.8\text{ W}$	128	15.4	$7.2\text{ E}+6$

Note: Worst case condition with no RF applied, 100% of DC power is dissipated. Package backside temperature @ 85°C

Typical Measured S-Parameters (75 Ω)
Using Application Circuit
(includes effects of external baluns)

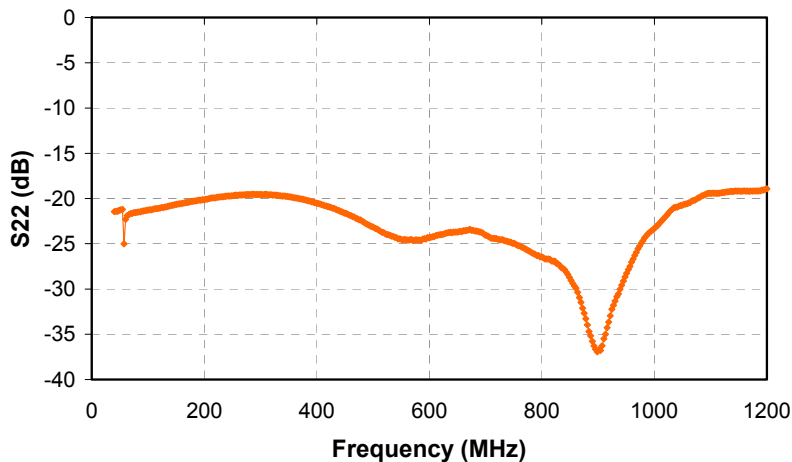
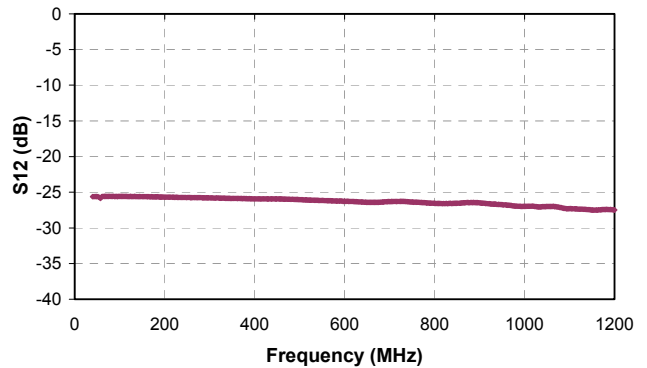
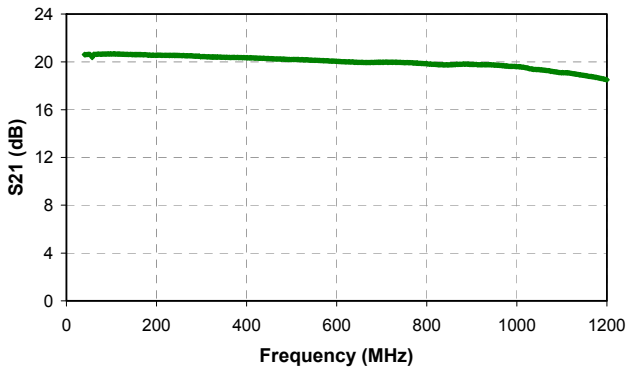
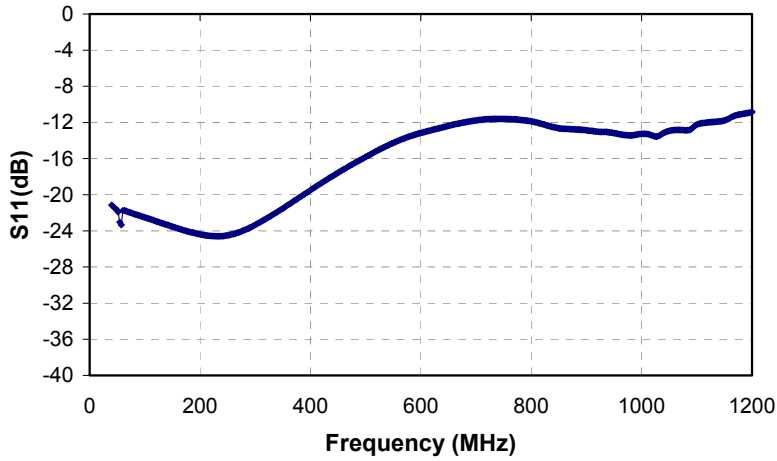

**Typical Measured Performance
Using Application Circuit**
(includes effects of external baluns)

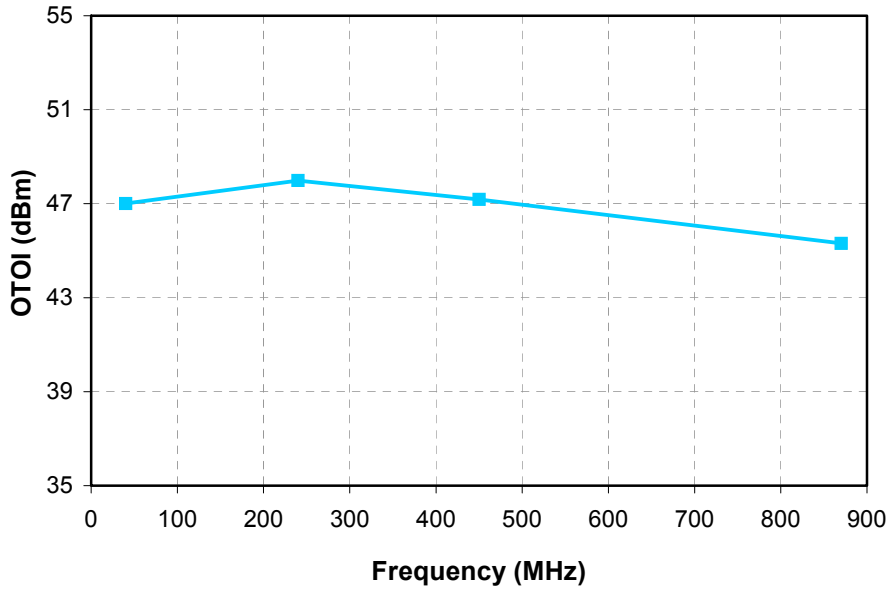

Input balun losses removed

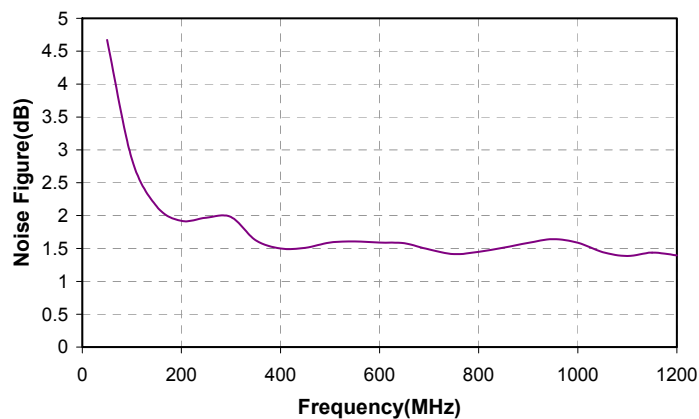
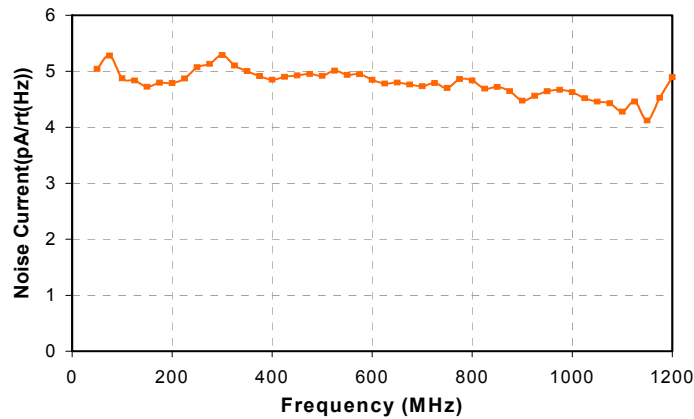

Pinout

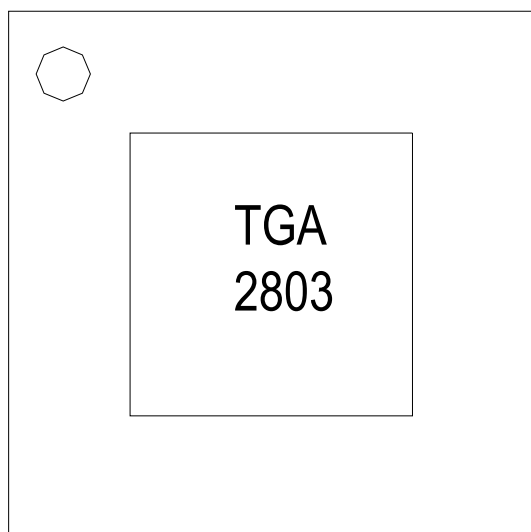

Top Side

Dot indicates Pin 1

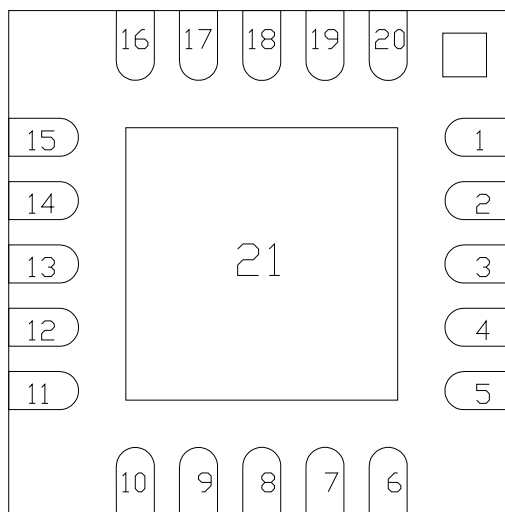

Bottom Side

Pin	Description	Pin	Description
1	RF Input 1	11	RF Output 2
2	RF Input 1	12	RF Output 2
3	GND	13, 21	GND
4	RF Input 2	14	RF Output 1
5	RF Input 2	15	RF Output 1
6	NC	16	NC
7	VG2 (Optional)	17	VDD (choked)
8	VDD	18	VDD
9	VDD (choked)	19	VG1 (Optional)
10	Isense <u>1/</u>	20	NC

1/ Bias current monitor: $I_{sense} = (\text{Voltage}_{pin\ 10}) / 4\Omega$

Application Diagrams

Electrical Gain Amplifier

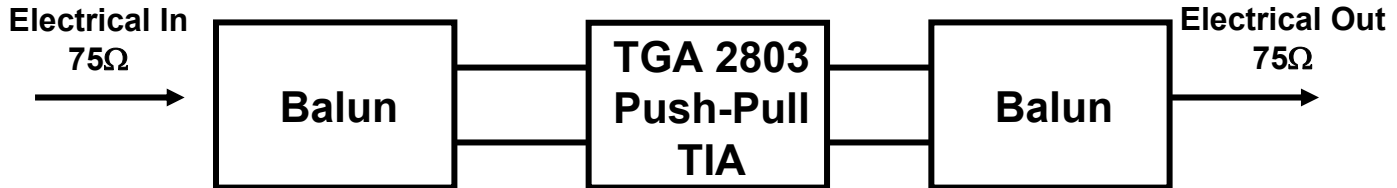

Optical Receiver

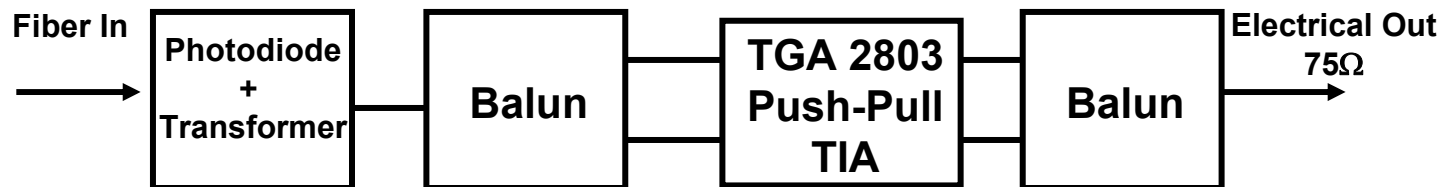

Recommended Electrical Assembly

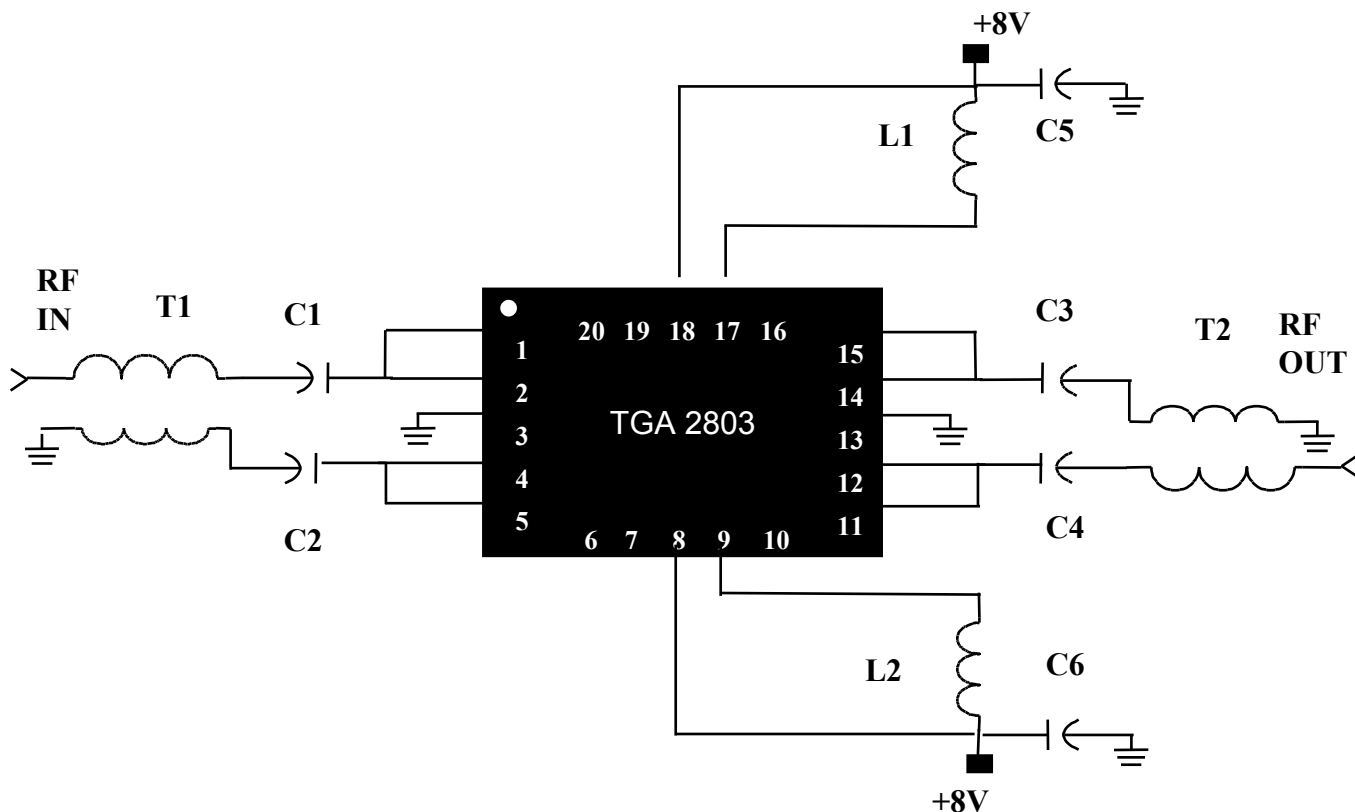

Component Description

Ref	Description
C1	0.01 μ F Capacitor
C2	0.01 μ F Capacitor
C3	470pF Capacitor
C4	470pF Capacitor
C5	270pF Capacitor
C6	270pF Capacitor
L1	820nH Inductor
L2	820nH Inductor
T1	Balun <u>1/</u>
T2	Balun <u>1/</u>

1/ Balun performance impacts amplifier return losses and gain. Best performance can be achieved by winding 34 or 36 gauge bifilar wire around a small binocular core made from low-loss magnetic material. Suitable wire may be obtained from MWS Wire Industries. Core vendors include Ferronics, Fairrite, TDK, and Micrometals.

Alternatively, off-the-shelf baluns can be purchased from a number of vendors including Mini-Circuits (ADTL1-18-75), M/A-COM (ETC1-1-13), and Pulse Engineering (CX2071).

Recommended Electro-Optical Assembly

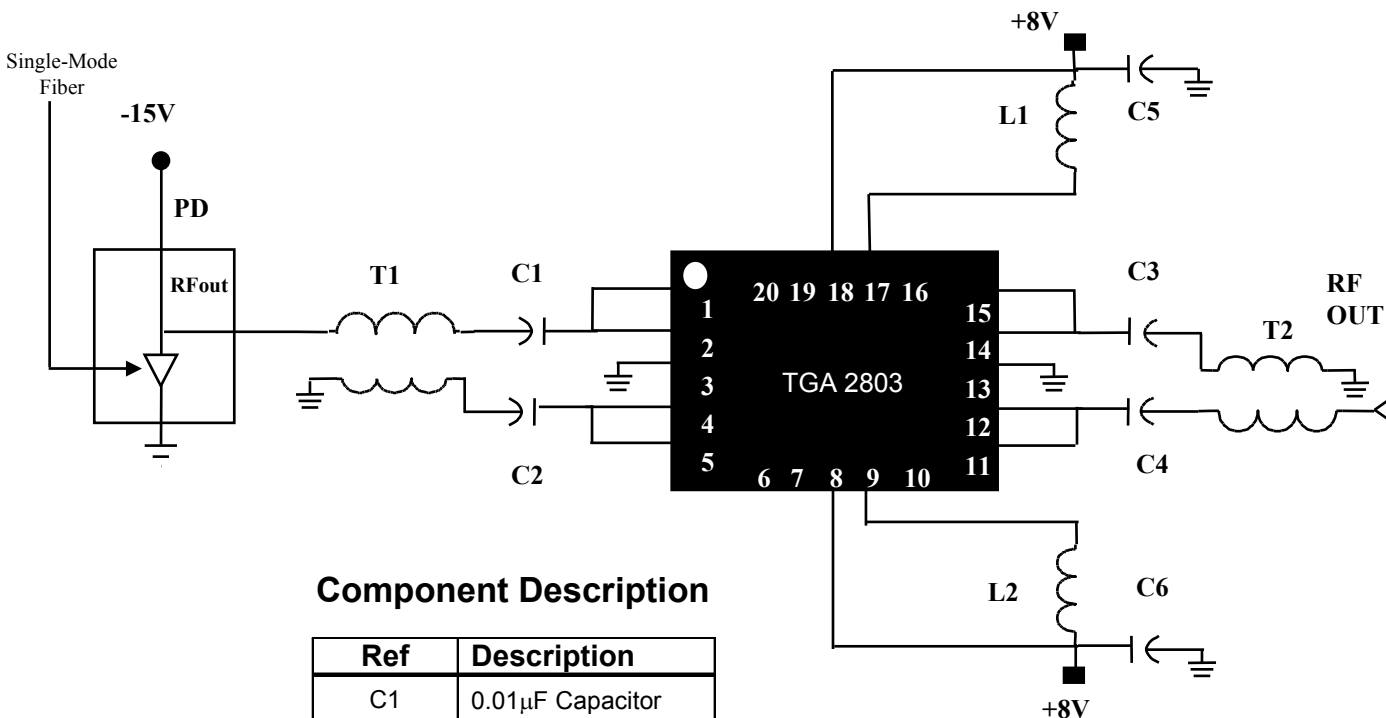

Component Description

Ref	Description
C1	0.01 μ F Capacitor
C2	0.01 μ F Capacitor
C3	470pF Capacitor
C4	470pF Capacitor
C5	270pF Capacitor
C6	270pF Capacitor
L1	820nH Inductor
L2	820nH Inductor
T1	Balun <u>1/</u>
T2	Balun <u>1/</u>
PD	Broadband Photodiode <u>2/</u>

1/ Balun performance impacts amplifier return losses and gain. Best performance can be achieved by winding 34 or 36 gauge bifilar wire around a small binocular core made from low-loss magnetic material. Suitable wire may be obtained from MWS Wire Industries. Core vendors include Ferronics, Fairrite, TDK, and Micrometals.

Alternatively, off-the-shelf baluns can be purchased from a number of vendors including Mini-Circuits (ADTL1-18-75), M/A-COM (ETC1-1-13), and Pulse Engineering (CX2071).

2/ Emcore 2609C Broadband Photodiode Module is recommended. The module includes a 4:1 impedance transformer.

Recommended Surface Mount Package Assembly

Proper ESD precautions must be followed while handling packages.

Clean the board with acetone. Rinse with alcohol. Allow the circuit to fully dry.

TriQuint recommends using a conductive solder paste for attachment. Follow solder paste and reflow oven vendors' recommendations when developing a solder reflow profile. Typical solder reflow profiles are listed in the table below.

Hand soldering is not recommended. Solder paste can be applied using a stencil printer or dot placement. The volume of solder paste depends on PCB and component layout and should be well controlled to ensure consistent mechanical and electrical performance.

Clean the assembly with alcohol.

Typical Solder Reflow Profiles

Reflow Profile	SnPb	Pb Free
Ramp-up Rate	3 °C/sec	3 °C/sec
Activation Time and Temperature	60 – 120 sec @ 140 – 160 °C	60 – 180 sec @ 150 – 200 °C
Time above Melting Point	60 – 150 sec	60 – 150 sec
Max Peak Temperature	240 °C	260 °C
Time within 5 °C of Peak Temperature	10 – 20 sec	10 – 20 sec
Ramp-down Rate	4 – 6 °C/sec	4 – 6 °C/sec

Ordering Information

Part	Package Style
TGA2803-SM	QFN 20L 4x4 Surface Mount

GaAs MMIC devices are susceptible to damage from Electrostatic Discharge. Proper precautions should be observed during handling, assembly and test.